

**TEST PAPER OF JEE(MAIN) EXAMINATION – 2019**

**(Held On Saturday 12<sup>th</sup> JANUARY, 2019) TIME : 09 : 30 AM To 12 : 30 PM**

**PHYSICS**

1. Two light identical springs of spring constant  $k$  are attached horizontally at the two ends of a uniform horizontal rod  $AB$  of length  $\ell$  and mass  $m$ . The rod is pivoted at its centre 'O' and can rotate freely in horizontal plane. The other ends of the two springs are fixed to rigid supports as shown in figure. The rod is gently pushed through a small angle and released. The frequency of resulting oscillation is:

- (1)  $\frac{1}{2\pi} \sqrt{\frac{6k}{m}}$   
 (2)  $\frac{1}{2\pi} \sqrt{\frac{2k}{m}}$   
 (3)  $\frac{1}{2\pi} \sqrt{\frac{k}{m}}$   
 (4)  $\frac{1}{2\pi} \sqrt{\frac{3k}{m}}$

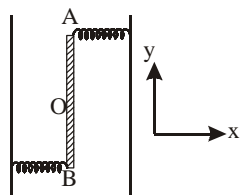

Ans. (1)

2. A cylinder of radius  $R$  is surrounded by a cylindrical shell of inner radius  $R$  and outer radius  $2R$ . The thermal conductivity of the material of the inner cylinder is  $K_1$  and that of the outer cylinder is  $K_2$ . Assuming no loss of heat, the effective thermal conductivity of the system for heat flowing along the length of the cylinder is:

- (1)  $K_1 + K_2$                       (2)  $\frac{K_1 + K_2}{2}$   
 (3)  $\frac{2K_1 + 3K_2}{5}$                       (4)  $\frac{K_1 + 3K_2}{4}$

Ans. (4)

3. A travelling harmonic wave is represented by the equation  $y(x, t) = 10^{-3} \sin(50t + 2x)$ , where  $x$  and  $y$  are in meter and  $t$  is in seconds. Which of the following is a correct statement about the wave?

- The wave is propagating along the  
 (1) negative  $x$ -axis with speed  $25\text{ms}^{-1}$   
 (2) The wave is propagating along the positive  $x$ -axis with speed  $25 \text{ ms}^{-1}$   
 (3) The wave is propagating along the positive  $x$ -axis with speed  $100 \text{ ms}^{-1}$   
 (4) The wave is propagating along the negative  $x$ -axis with speed  $100 \text{ ms}^{-1}$

Ans. (1)

4. A straight rod of length  $L$  extends from  $x = a$  to  $x=L+a$ . The gravitational force is exerts on a point mass ' $m$ ' at  $x = 0$ , if the mass per unit length of the rod is  $A + Bx^2$ , is given by:

- (1)  $Gm \left[ A \left( \frac{1}{a+L} - \frac{1}{a} \right) - BL \right]$   
 (2)  $Gm \left[ A \left( \frac{1}{a} - \frac{1}{a+L} \right) + BL \right]$   
 (3)  $Gm \left[ A \left( \frac{1}{a+L} - \frac{1}{a} \right) + BL \right]$   
 (4)  $Gm \left[ A \left( \frac{1}{a} - \frac{1}{a+L} \right) - BL \right]$

Ans. (2)

5. A light wave is incident normally on a glass slab of refractive index 1.5. If 4% of light gets reflected and the amplitude of the electric field of the incident light is  $30\text{V/m}$ , then the amplitude of the electric field for the wave propogating in the glass medium will be:

- (1)  $10 \text{ V/m}$   
 (2)  $24 \text{ V/m}$   
 (3)  $30 \text{ V/m}$   
 (4)  $6 \text{ V/m}$

Ans. (2)

6. The output of the given logic circuit is :

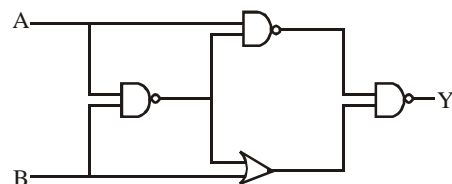

- (1)  $\bar{A}B$   
 (2)  $A\bar{B}$   
 (3)  $AB + \bar{A}\bar{B}$   
 (4)  $A\bar{B} + \bar{A}B$

Ans. (2)

7. In the figure shown, after the switch 'S' is turned from position 'A' to position 'B', the energy dissipated in the circuit in terms of capacitance 'C' and total charge 'Q' is:

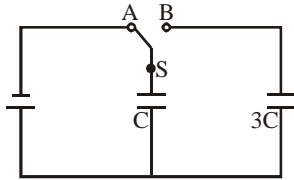

- (1)  $\frac{3Q^2}{8C}$  (2)  $\frac{3Q^2}{4C}$  (3)  $\frac{1Q^2}{8C}$  (4)  $\frac{5Q^2}{8C}$

Ans. (1)

8. A particle of mass  $m$  moves in a circular orbit in a central potential field  $U(r) = \frac{1}{2}kr^2$ . If Bohr's quantization conditions are applied, radii of possible orbitals and energy levels vary with quantum number  $n$  as:

- (1)  $r_n \propto n^2, E_n \propto \frac{1}{n^2}$  (2)  $r_n \propto \sqrt{n}, E_n \propto \frac{1}{n}$   
(3)  $r_n \propto n, E_n \propto n$  (4)  $r_n \propto \sqrt{n}, E_n \propto n$

Ans. (4)

9. Two electric bulbs, rated at (25 W, 220 V) and (100 W, 220 V), are connected in series across a 220 V voltage source. If the 25 W and 100 W bulbs draw powers  $P_1$  and  $P_2$  respectively, then:

- (1)  $P_1 = 9 \text{ W}, P_2 = 16 \text{ W}$   
(2)  $P_1 = 4 \text{ W}, P_2 = 16 \text{ W}$   
(3)  $P_1 = 16 \text{ W}, P_2 = 4 \text{ W}$   
(4)  $P_1 = 16 \text{ W}, P_2 = 9 \text{ W}$

Ans. (3)

10. A satellite of mass  $M$  is in a circular orbit of radius  $R$  about the centre of the earth. A meteorite of the same mass, falling towards the earth, collides with the satellite completely inelastically. The speeds of the satellite and the meteorite are the same, just before the collision. The subsequent motion of the combined body will be :

- (1) in a circular orbit of a different radius  
(2) in the same circular orbit of radius  $R$   
(3) in an elliptical orbit  
(4) such that it escapes to infinity

Ans. (3)

11. Let the moment of inertia of a hollow cylinder of length 30 cm (inner radius 10 cm and outer radius 20 cm), about its axis be  $I$ . The radius of a thin cylinder of the same mass such that its moment of inertia about its axis is also  $I$ , is:

- (1) 12 cm (2) 18 cm (3) 16 cm (4) 14 cm

Ans. (3)

12. A passenger train of length 60m travels at a speed of 80 km/hr. Another freight train of length 120 m travels at a speed of 30 km/hr. The ratio of times taken by the passenger train to completely cross the freight train when : (i) they are moving in the same direction, and (ii) in the opposite directions is :

- (1)  $\frac{5}{2}$  (2)  $\frac{25}{11}$  (3)  $\frac{3}{2}$  (4)  $\frac{11}{5}$

Ans. (4)

13. An ideal gas occupies a volume of  $2\text{m}^3$  at a pressure of  $3 \times 10^6 \text{ Pa}$ . The energy of the gas is:
- (1)  $3 \times 10^2$  (2)  $10^8 \text{ J}$   
(3)  $6 \times 10^4 \text{ J}$  (4)  $9 \times 10^6 \text{ J}$

Ans. (4)

14. A 100 V carrier wave is made to vary between 160 V and 40 V by a modulating signal. What is the modulation index?

- (1) 0.6 (2) 0.5 (3) 0.3 (4) 0.4

Ans. (1)

15. The galvanometer deflection, when key  $K_1$  is closed but  $K_2$  is open, equals  $\theta_0$  (see figure). On closing  $K_2$  also and adjusting  $R_2$  to  $5\Omega$ , the

deflection in galvanometer becomes  $\frac{\theta_0}{5}$ . The

resistance of the galvanometer is, then, given by [Neglect the internal resistance of battery]:

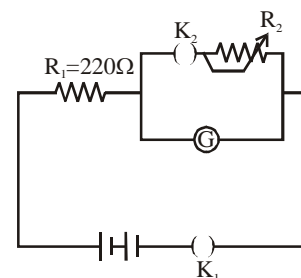

- (1)  $12\Omega$  (2)  $25\Omega$  (3)  $5\Omega$  (4)  $22\Omega$

Ans. (4)

16. A person standing on an open ground hears the sound of a jet aeroplane, coming from north at an angle  $60^\circ$  with ground level. But he finds the aeroplane right vertically above his position. If  $v$  is the speed of sound, speed of the plane is :

- (1)  $\frac{2v}{\sqrt{3}}$  (2)  $v$   
(3)  $\frac{v}{2}$  (4)  $\frac{\sqrt{3}}{2}v$

Ans. (3)

17. A proton and an  $\alpha$ -particle (with their masses in the ratio of 1:4 and charges in the ratio of 1:2) are accelerated from rest through a potential difference  $V$ . If a uniform magnetic field ( $B$ ) is set up perpendicular to their velocities, the ratio of the radii  $r_p : r_\alpha$  of the circular paths described by them will be :

- (1)  $1:\sqrt{2}$  (2)  $1:2$  (3)  $1:3$  (4)  $1:\sqrt{3}$

Ans. (1)

18. A point source of light,  $S$  is placed at a distance  $L$  in front of the centre of plane mirror of width  $d$  which is hanging vertically on a wall. A man walks in front of the mirror along a line parallel to the mirror, at a distance  $2L$  as shown below. The distance over which the man can see the image of the light source in the mirror is :

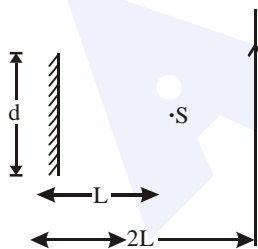

- (1)  $3d$  (2)  $\frac{d}{2}$   
(3)  $d$  (4)  $2d$

Ans. (1)

19. The least count of the main scale of a screw gauge is 1 mm. The minimum number of divisions on its circular scale required to measure  $5\mu\text{m}$  diameter of wire is :

- (1) 50 (2) 100  
(3) 200 (4) 500

Ans. (3)

20. A simple pendulum, made of a string of length  $l$  and a bob of mass  $m$ , is released from a small angle  $\theta_0$ . It strikes a block of mass  $M$ , kept on a horizontal surface at its lowest point of oscillations, elastically. It bounces back and goes up to an angle  $\theta_1$ . Then  $M$  is given by :

- (1)  $\frac{m}{2} \left( \frac{\theta_0 - \theta_1}{\theta_0 + \theta_1} \right)$  (2)  $\frac{m}{2} \left( \frac{\theta_0 + \theta_1}{\theta_0 - \theta_1} \right)$   
(3)  $m \left( \frac{\theta_0 + \theta_1}{\theta_0 - \theta_1} \right)$  (4)  $m \left( \frac{\theta_0 - \theta_1}{\theta_0 + \theta_1} \right)$

Ans. (3)

21. What is the position and nature of image formed by lens combination shown in figure? ( $f_1, f_2$  are focal lengths)

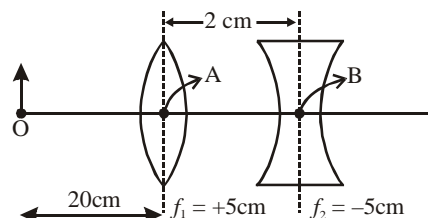

- (1) 70 cm from point B at left; virtual  
(2) 40 cm from point B at right; real  
(3)  $\frac{20}{3}$  cm from point B at right, real  
(4) 70 cm from point B at right, real

Ans. (4)

**MAJOR COMPUTER BASED TEST (CBT) SERIES**

**JEE (Advanced)- Target 2019**

[dlp.allen.ac.in](http://dlp.allen.ac.in)

Test Dates: 3<sup>rd</sup> Feb, 21<sup>st</sup> & 28<sup>th</sup> April, 12<sup>th</sup> May

0744-2750275

22. In the figure shown, a circuit contains two identical resistors with resistance  $R = 5\Omega$  and an inductance with  $L = 2\text{mH}$ . An ideal battery of  $15\text{ V}$  is connected in the circuit. What will be the current through the battery long after the switch is closed?

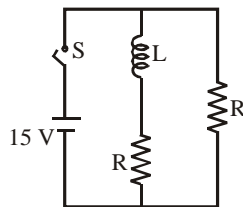

- (1) 6A
- (2) 7.5A
- (3) 5.5A
- (4) 3A

Ans. (1)

23. Determine the electric dipole moment of the system of three charges, placed on the vertices of an equilateral triangle, as shown in the figure:

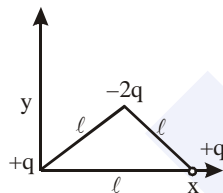

- (1)  $(q\ell)\frac{\hat{i}+\hat{j}}{\sqrt{2}}$
- (2)  $\sqrt{3}q\ell\frac{\hat{j}-\hat{i}}{\sqrt{2}}$
- (3)  $-\sqrt{3}q\ell\hat{j}$
- (4)  $2q\ell\hat{j}$

Ans. (3)

24. The position vector of the centre of mass  $\vec{r}_{cm}$  of an symmetric uniform bar of negligible area of cross-section as shown in figure is :

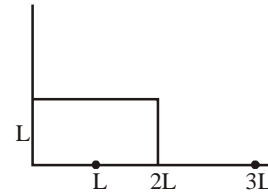

- (1)  $\vec{r}_{cm} = \frac{13}{8}L\hat{x} + \frac{5}{8}L\hat{y}$
- (2)  $\vec{r}_{cm} = \frac{11}{8}L\hat{x} + \frac{3}{8}L\hat{y}$
- (3)  $\vec{r}_{cm} = \frac{3}{8}L\hat{x} + \frac{11}{8}L\hat{y}$
- (4)  $\vec{r}_{cm} = \frac{5}{8}L\hat{x} + \frac{13}{8}L\hat{y}$

Ans. (1)

25. As shown in the figure, two infinitely long, identical wires are bent by  $90^\circ$  and placed in such a way that the segments LP and QM are along the x-axis, while segments PS and QN are parallel to the y-axis. If  $OP = OQ = 4\text{cm}$ , and the magnitude of the magnetic field at O is  $10^{-4}\text{ T}$ , and the two wires carry equal currents (see figure), the magnitude of the current in each wire and the direction of the magnetic field at O will be ( $\mu_0 = 4\pi \times 10^{-7}\text{ NA}^{-2}$ ) :

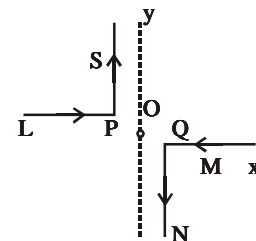

- (1) 40 A, perpendicular into the page
- (2) 40 A, perpendicular out of the page
- (3) 20 A, perpendicular out of the page
- (4) 20 A, perpendicular into the page

Ans. (4)

**MAJOR COMPUTER BASED TEST (CBT) SERIES**

**JEE (Main)- Target 2019**

[dlp.allen.ac.in](http://dlp.allen.ac.in)

Test Dates: 24<sup>th</sup> & 31<sup>st</sup> March

0744-2750275

26. In a meter bridge, the wire of length 1 m has a non-uniform cross-section such that, the variation  $\frac{dR}{dl}$  of its resistance R with length  $l$  is  $\frac{dR}{dl} \propto \frac{1}{\sqrt{l}}$ . Two equal resistances are connected as shown in the figure. The galvanometer has zero deflection when the jockey is at point P. What is the length AP?

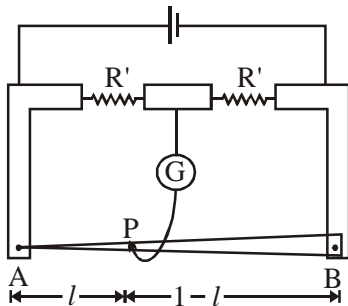

- (1) 0.25 m                      (2) 0.3 m  
(3) 0.35 m                      (4) 0.2 m

**Ans. (1)**

27. For the given cyclic process CAB as shown for a gas, the work done is :

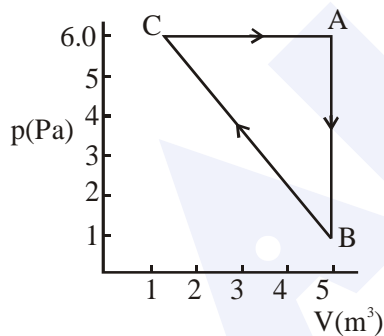

- (1) 1 J                              (2) 5 J  
(3) 10 J                            (4) 30 J

**Ans. (3)**

28. An ideal battery of 4 V and resistance R are connected in series in the primary circuit of a potentiometer of length 1 m and resistance  $5\Omega$ . The value of R, to give a potential difference of 5 mV across 10 cm of potentiometer wire, is :
- (1) 490  $\Omega$                       (2) 480  $\Omega$   
(3) 395  $\Omega$                       (4) 495  $\Omega$

**Ans. (3)**

29. A particle A of mass 'm' and charge 'q' is accelerated by a potential difference of 50 V. Another particle B of mass '4 m' and charge 'q' is accelerated by a potential difference of 2500 V.

The ratio of de-Broglie wavelengths  $\frac{\lambda_A}{\lambda_B}$  is close to :

- (1) 10.00    (2) 14.14    (3) 4.47    (4) 0.07

**Ans. (2)**

30. There is a uniform spherically symmetric surface charge density at a distance  $R_0$  from the origin. The charge distribution is initially at rest and starts expanding because of mutual repulsion. The figure that represents best the speed  $V(R(t))$  of the distribution as a function of its instantaneous radius  $R(t)$  is :

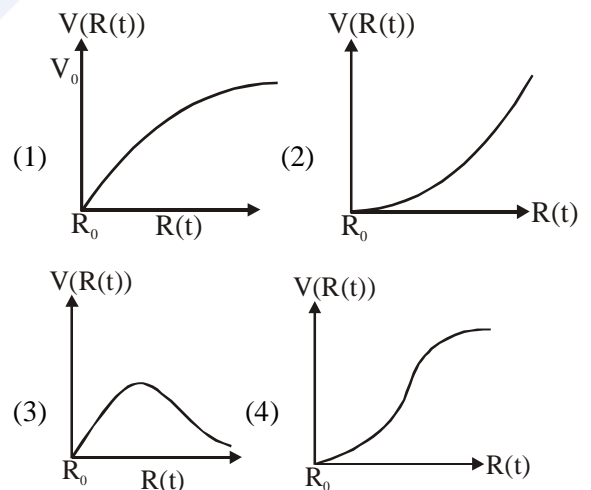

**Ans. (1)**